

DWG No
TRA-CD2

DO NOT SCALE

THIRD ANGLE PROJECTION

DXF File Name

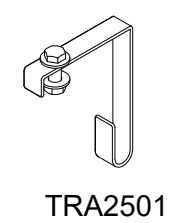
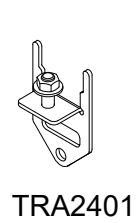
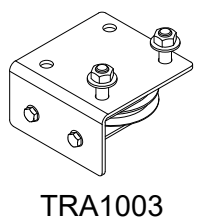
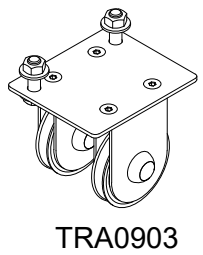
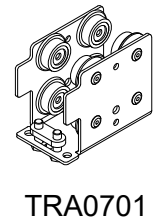
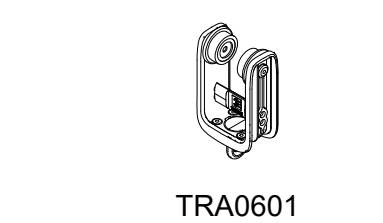
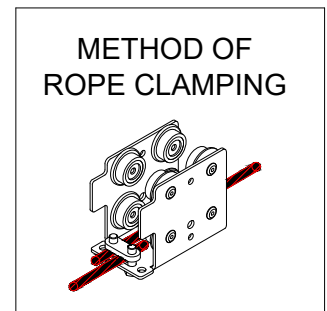
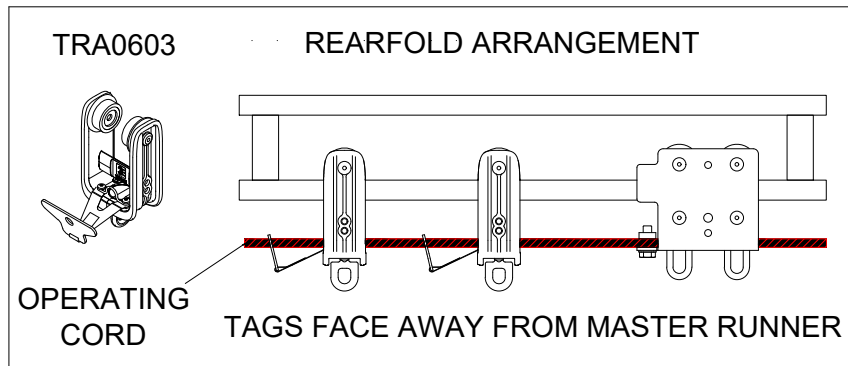
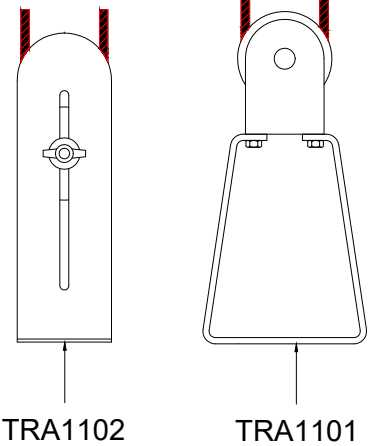
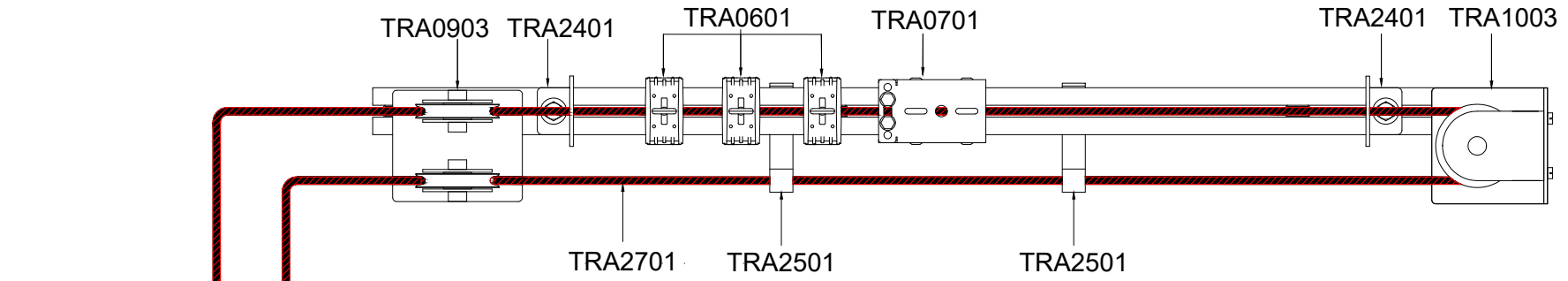

TRIPLE E LTD
16 AIRPORT IND EST
MAIN ROAD, BIGGIN HILL
KENT, TN16 3BW
TEL: +44 (0) 1959 570333
FAX: +44 (0) 1959 570888

© TRIPLE E LTD
THE CONTENTS OF THIS
DRAWING CONSTITUTES
DESIGN COPYRIGHT AND
MAY NOT BE REPRODUCED
OR DISCLOSED TO A THIRD
PARTY WITHOUT PRIOR
PERMISSION IN WRITING
FROM TRIPLE E LTD

TITLE Standard Wipe Track Viewed From Underside	
ALL DIMENSIONS IN MILLIMETRES (mm) TOLERANCES UNLESS OTHERWISE STATED DIMENSIONAL ±0.2	MATERIAL
	FINISH

SPECIAL INSTRUCTIONS

DRAWN	LE	SCALE
APPD		DATE 2017
PART No		DWG No Rev